

LH0036 Instrumentation Amplifier

General Description

The LH0036C is a micro power instrumentation amplifier designed for precision differential signal processing. Extremely high accuracy can be obtained due to the 300 MΩ input impedance and excellent 100 dB common mode rejection ratio. It is packaged in a hermetic TO-8 package. Gain is programmable from 1 to 1000 with a single external resistor. Power supply operating range is between ±1V and ±18V. Input bias current and output bandwidth are both externally adjustable or can be set by internally set values. The LH0036C is specified for operation over the -25°C to +85°C temperature range.

Features

- High input impedance 300 MΩ
- High CMRR 100 dB
- Single resistor gain adjust 1 to 1000
- Low power 90 μW
- Wide supply range ±1V to ±18V
- Adjustable input bias current
- Adjustable output bandwidth
- Guard drive output

Equivalent Circuit and Connection Diagrams

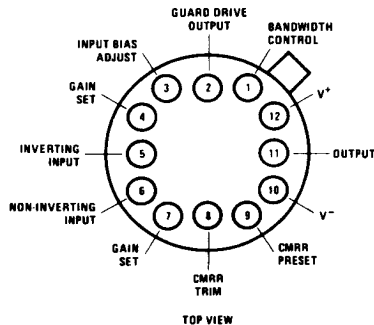
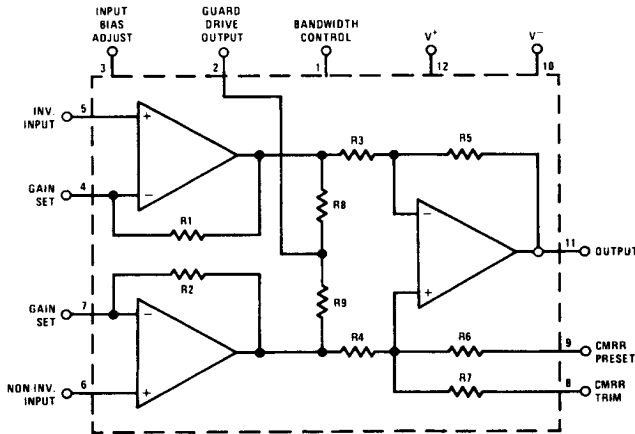

Order Number LH0036CG
See NS Package Number G12B

TL/H/5545-1

Absolute Maximum Ratings

If Military/Aerospace specified devices are required, please contact the National Semiconductor Sales Office/Distributors for availability and specifications. (Note 5)

Supply Voltage	$\pm 18V$
Differential Input Voltage	$\pm 30V$
Input Voltage Range	$\pm V_S$
Shield Drive Voltage	$\pm V_S$
CMMR Preset Voltage	$\pm V_S$

CMMR Trim Voltage	$\pm V_S$
Power Dissipation (Note 3)	1.5W
Short Circuit Duration	Continuous
Storage Temperature Range	$-65^{\circ}C$ to $+150^{\circ}C$
Lead Temperature (Soldering, 10 sec.)	$260^{\circ}C$

Operating Temperature Range

LH0036C	$-25^{\circ}C$ to $+85^{\circ}C$
ESD rating to be determined.	

Electrical Characteristics (Notes 1 and 2)

Parameter	Conditions	Limits			Units
		LH0036C			
		Min	Typ	Max	
Input Offset Voltage (V_{IOS})	$R_S = 1.0\text{ k}\Omega$, $T_A = 25^{\circ}C$		1.0	2.0	mV
	$R_S = 1.0\text{ k}\Omega$			3.0	mV
Output Offset Voltage (V_{OOS})	$R_S = 1.0\text{ k}\Omega$, $T_A = 25^{\circ}C$		5.0	10	mV
	$R_S = 1.0\text{ k}\Omega$			12	mV
Input Offset Voltage Tempco ($\Delta V_{IOS}/\Delta T$)	$R_S \leq 1.0\text{ k}\Omega$		10		$\mu V/^{\circ}C$
Output Offset Voltage Tempco ($\Delta V_{OOS}/\Delta T$)			15		$\mu V/^{\circ}C$
Overall Offset Referred to Input (V_{OS})	$A_V = 1.0$		6.0		mV
	$A_V = 10$		1.5		mV
	$A_V = 100$		1.05		mV
	$A_V = 1000$		1.005		mV
Input Bias Current (I_B)	$T_A = 25^{\circ}C$		50	125	nA
				200	nA
Input Offset Current (I_{OS})	$T_A = 25^{\circ}C$		20	50	nA
				100	nA
Input Voltage Range	Differential	± 10	± 12		V
	Common Mode	± 10	± 12		V
Gain Nonlinearity			0.03		%
Deviation From Gain Equation Formula	$A_V = 1$ to 1000 (Note 4)		± 1.0	± 3.0	%

Electrical Characteristics (Notes 1 and 2) (Continued)

Parameter	Conditions	Limits			Units
		LH0036C			
		Min	Typ	Max	
PSRR	$\pm 5.0V \leq V_S \leq \pm 15V, A_V = 1.0$		1.0	5.0	mV/V
	$\pm 5.0V \leq V_S \leq \pm 15V, A_V = 100$		0.10	0.50	mV/V
CMRR	$A_V = 1.0$ DC to		2.5	5.0	mV/V
	$A_V = 10$ 100 Hz		0.25	0.50	mV/V
	$A_V = 100$ $\Delta R_S = 1.0k$		50	100	$\mu V/V$
Output Voltage	$V_S = \pm 15V, R_L = 10 k\Omega$	± 10	± 13.5		V
	$V_S = \pm 1.5V, R_L = 100 k\Omega$	± 0.6	± 0.8		V
Output Resistance			0.5		Ω
Supply Current			400	600	μA
Small Signal Bandwidth	$A_V = 1.0, R_L = 10 k\Omega$		350		kHz
	$A_V = 10, R_L = 10 k\Omega$		35		kHz
	$A_V = 100, R_L = 10 k\Omega$		3.5		kHz
	$A_V = 1000, R_L = 10 k\Omega$		350		Hz
Full Power Bandwidth	$V_{IN} = \pm 10V, R_L = 10k, A_V = 1$		5.0		kHz
Equivalent Input Noise Voltage	0.1 Hz < f < 10 kHz, $R_S < 50\Omega$		20		$\mu V/p-p$
Slew Rate	$\Delta V_{IN} = \pm 10V,$ $R_L = 10 k\Omega, A_V = 1.0$		0.3		V/ μS
Settling Time	$T_O \pm 10 mV, R_L = 10 k\Omega,$ $\Delta V_{OUT} = 1.0V$				
	$A_V = 1.0$		3.8		μS
	$A_V = 100$		180		μS

Note 1: Unless otherwise specified, all specifications apply for $V_S = \pm 15V$, Pins 1, 3, and 9 grounded, $-25^\circ C$ to $+85^\circ C$.

Note 2: All typical values are for $T_A = 25^\circ C$.

Note 3: The maximum junction temperature is $150^\circ C$. For operation at elevated temperature derate the G package on a thermal resistance of $90^\circ C/W$.

Note 4: $A_V = 1000$ guaranteed by design and testing at $A_V = 100$.

Typical Performance Characteristics

Supply Current vs Temperature

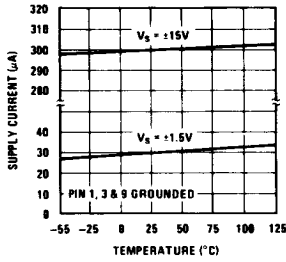

Supply Current vs Supply Voltage

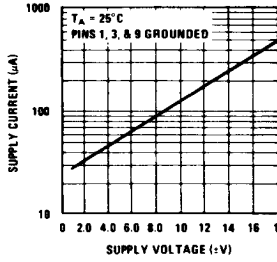

Output Voltage Swing vs Supply Voltage

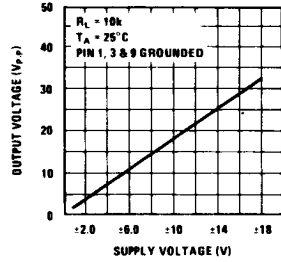

Peak to Peak Output Voltage Swing vs R_L

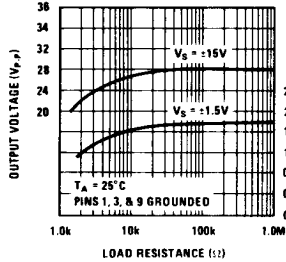

Total Input Noise Voltage* vs Frequency

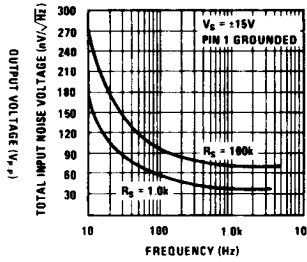

Closed Loop Voltage Gain vs Frequency

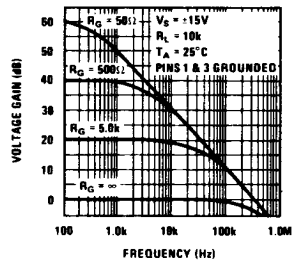

*Noise voltage includes contribution from source resistance

Closed Loop Voltage Gain

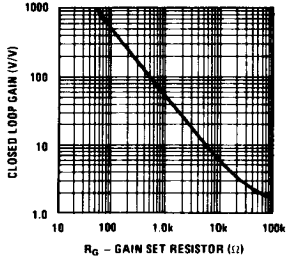

CMRR vs Frequency

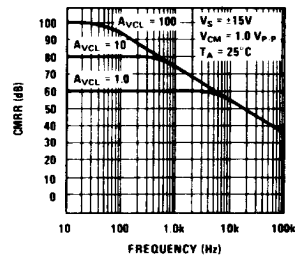

Common Mode Voltage vs Supply Voltage

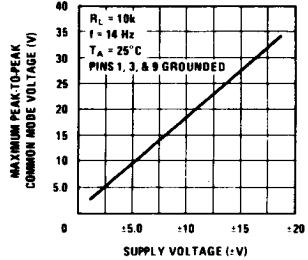

Input Bias Current

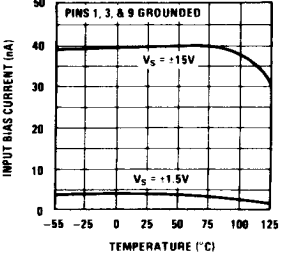

Output Voltage Swing vs Frequency

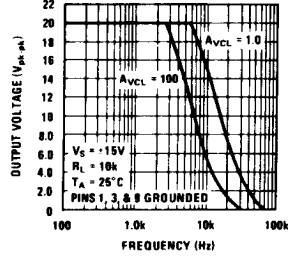

Large Signal Pulse Response

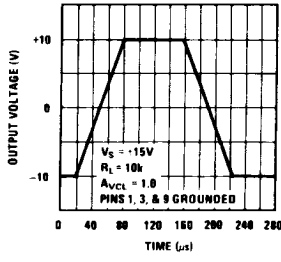

Typical Applications

Pre MUX Signal Conditioning

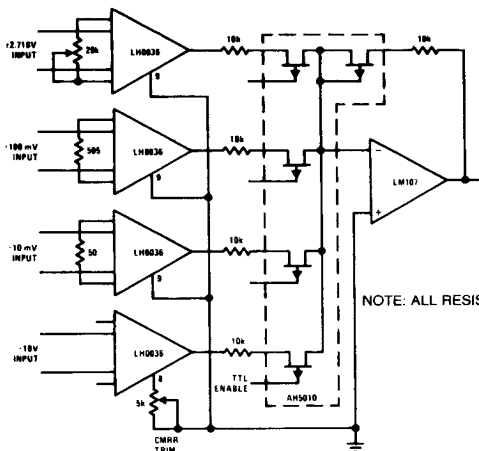

NOTE: ALL RESISTORS ARE 0.1%

Instrumentation Amplifier with Logic Controlled Shut-Down

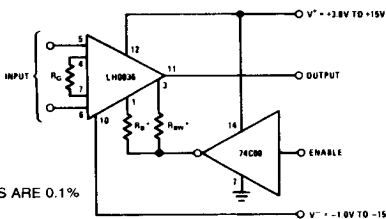

*R_{bW} AND R_b ARE OPTIONAL BANDWIDTH AND INPUT BIAS CURRENT CONTROLLING RESISTORS.

Isolation Amplifier for Medical Telemetry

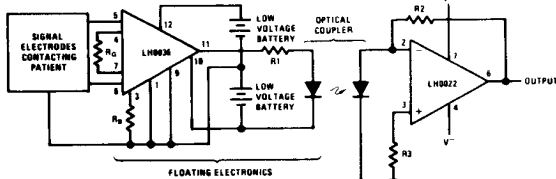

Thermocouple Amplifier with Cold Junction Compensation

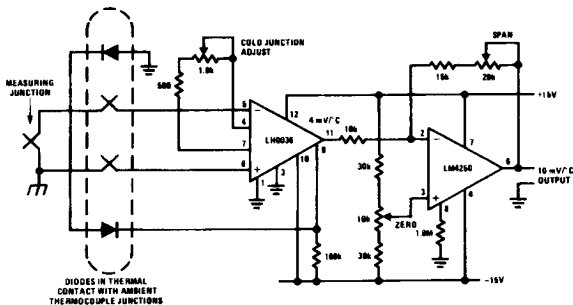

Process Control Interface

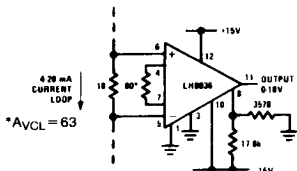

High Pass Filter

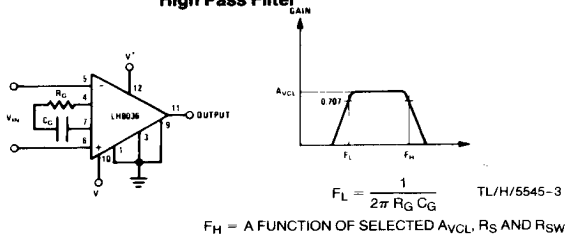

Applications Information

THEORY OF OPERATION

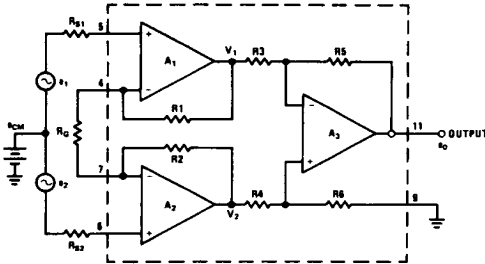

FIGURE 1. Simplified LH0036

TL/H/5545-4

The LH0036 is a 2 stage amplifier with a high input impedance gain stage comprised of A₁ and A₂ and a differential to single-ended unity gain stage, A₃. Operational amplifier, A₁, receives differential input signal, e₁, and amplifies it by a factor equal to (R₁ + R_G)/R_G.

A₁ also receives input e₂ via A₂ and R₂. e₂ is seen as an inverting signal with a gain of R₁/R_G. A₁ also receives the common mode signal e_{CM} and processes it with a gain of +1.

Hence:

$$V_1 = \frac{R_1 + R_G}{R_G} e_1 - \frac{R_1}{R_G} e_2 + e_{CM} \quad (1)$$

By similar analysis V₂ is seen to be:

$$V_2 = \frac{R_2 + R_G}{R_G} e_2 - \frac{R_2}{R_G} e_1 + e_{CM} \quad (2)$$

For R₁ = R₂:

$$V_2 - V_1 = \left[\left(\frac{2R_1}{R_G} \right) + 1 \right] (e_2 - e_1) \quad (3)$$

Also, for R₃ = R₅ = R₄ = R₆, the gain of A₃ = 1, and:

$$e_0 = (1)(V_2 - V_1) = (e_2 - e_1) \left[1 + \left(\frac{2R_1}{R_G} \right) \right] \quad (4)$$

As can be seen for identically matched resistors, e_{CM} is cancelled out, and the differential gain is dictated by equation (4).

For the LH0036, equation (4) reduces to:

$$A_{VCL} = \frac{e_0}{e_2 - e_1} = 1 + \frac{50k}{R_G} \quad (5a)$$

The closed loop gain may be set to any value from 1 (R_G = ∞) to 1000 (R_G ≈ 50Ω). Equation (5a) re-arranged in more convenient form may be used to select R_G for a desired gain:

$$R_G = \frac{50k}{A_{VCL} - 1} \quad (5b)$$

USE OF BANDWIDTH CONTROL (pin 1)

In the standard configuration, pin 1 of the LH0036 is simply grounded. The amplifier's slew rate in this configuration is

typically 0.3V/μS and small signal bandwidth 350 kHz for A_{VCL} = 1. In some applications, particularly at low frequency, it may be desirable to limit bandwidth in order to minimize the overall noise bandwidth of the device. A resistor R_{BW} may be placed between pin 1 and ground to accomplish this purpose. Figure 2 shows typical small signal bandwidth versus R_{BW}.

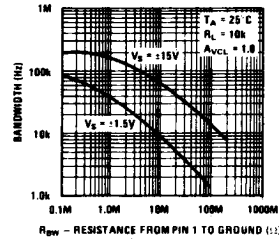

FIGURE 2. Bandwidth vs R_{BW}

TL/H/5545-5

It also should be noted that large signal bandwidth and slew rate may be adjusted down by use of R_{BW}. Figure 3 is plot of slew rate versus R_{BW}.

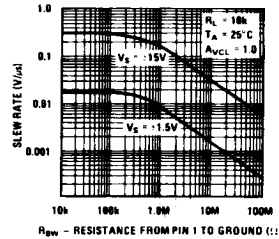

FIGURE 3. Output Slew Rate vs R_{BW}

TL/H/5545-6

CMRR CONSIDERATIONS

Use of Pin 9, CMRR Preset

Pin 9 should be grounded for nominal operation. An internal factory trimmed resistor, R₆, will yield a CMRR in excess of 80 dB (for A_{VCL} = 100). Should a higher CMRR be desired, pin 9 should be left open and the procedure, in this section followed.

DC Off-set Voltage and Common Mode Rejection Adjustments

Off-set may be nulled using the circuit in Figure 4.

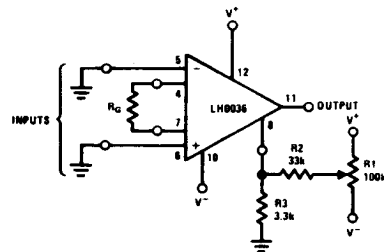

FIGURE 4. V_{OS} Adjustment Circuit

TL/H/5545-7

Applications Information (Continued)

Pin 8 is also used to improve the common mode rejection ratio as shown in *Figure 5*. Null is achieved by alternately applying $\pm 10V$ (for V^+ & $V^- = 15V$) to the inputs and adjusting R_1 for minimum change at the output.

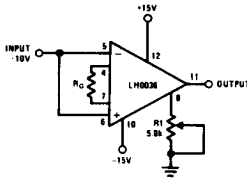

FIGURE 5. CMRR Adjustment Circuit

TL/H/5545-8

The circuits of *Figure 4* and *5* may be combined as shown in *Figure 6* to accomplish both V_{OS} and CMRR null. However, the V_{OS} and CMRR adjustment are interactive and several iterations are required. The procedure for null should start with the inputs grounded.

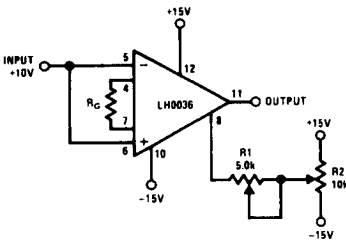
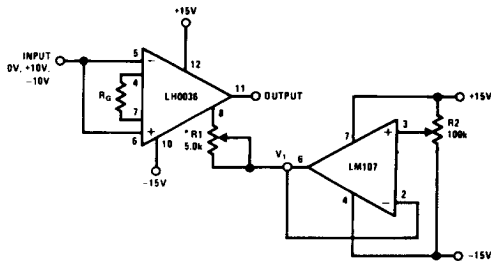

FIGURE 6. Combined CMRR, V_{OS} Adjustment Circuit

TL/H/5545-10

R_2 is adjusted for V_{OS} null. An input of $+10V$ is then applied and R_1 is adjusted for CMRR null. The procedure is then repeated until the optimum is achieved.

A circuit which overcomes adjustment interaction is shown in *Figure 7*. In this case, R_2 is adjusted first for output null of the LH0036. R_1 is then adjusted for output null with $+10V$ input. It is always a good idea to check CMRR null with a $-10V$ input. The optimum null achievable will yield the highest CMRR over the amplifiers common mode range.



*Note: Nominal value R_1 to Achieve Optimum CMRR is 3.0 k Ω

FIGURE 7. Improved V_{OS} , CMRR Nulling Circuit

TL/H/5545-11

AC CMRR Considerations

The ac CMRR may be improved using the circuit of *Figure 8*.

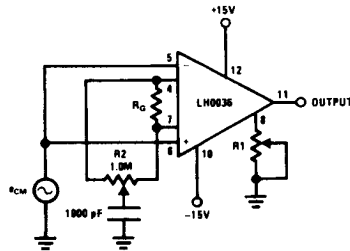

FIGURE 8. Improved AC CMRR Circuit

TL/H/5545-9

After adjusting R_1 for best dc CMRR as before, R_2 should be adjusted for minimum peak-to-peak voltage at the output while applying an ac common mode signal of the maximum amplitude and frequency of interest.

INPUT BIAS CURRENT CONTROL

Under nominal operating conditions (pin 3 grounded), the LH0036 requires input currents of 40 nA. The input current may be reduced by inserting a resistor (R_B) between 3 and ground or, alternatively, between 3 and V^- . For R_B returned to ground, the input bias current may be predicted by:

$$I_{BIAS} \approx \frac{V^+ - 0.5}{4 \times 10^8 + 800 R_B} \quad (6a)$$

or

$$R_B = \frac{V^+ - 0.5 - (4 \times 10^8) (I_{BIAS})}{800 I_{BIAS}} \quad (6b)$$

Where:

I_{BIAS} = Input Bias Current (nA)

R_B = External Resistor connected between pin 3 and ground (Ohms)

V^+ = Positive Supply Voltage (Volts)

Figure 9 is a plot of input bias current versus R_B .

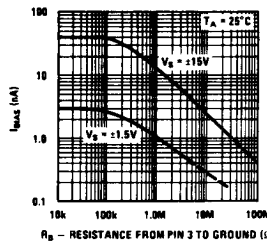

TL/H/5545-12

FIGURE 9. Input Bias Current as a Function of R_B

As indicated above, R_B may be returned to the negative supply voltage. Input bias current may then be predicted by:

$$I_{BIAS} \approx \frac{(V^+ - V^-) - 0.5}{4 \times 10^8 + 800 R_B}$$

Applications Information (Continued)

or

$$R_B \cong \frac{(V^+ - V^-) - 0.5 - (4 \times 10^8)(I_{BIAS})}{800 I_{BIAS}} \quad (8)$$

Where:

- I_{BIAS} = Input Bias Current (nA)
- R_B = External resistor connected between pin 3 and V^- (Ohms)
- V^+ = Positive Supply Voltage (Volts)
- V^- = Negative Supply Voltage (Volts)

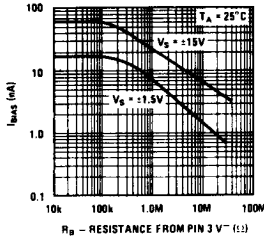

TL/H/5545-13

FIGURE 10. Input Bias Current as a Function of R_B

Figure 10 is a plot of input bias current versus R_B returned to V^- it should be noted that bandwidth is affected by changes in R_B . Figure 11 is a plot of bandwidth versus R_B .

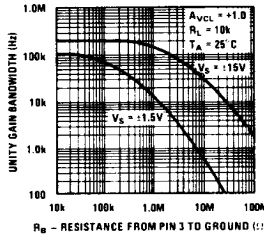

TL/H/5545-14

FIGURE 11. Unity Gain Bandwidth as a Function of R_B

BIAS CURRENT RETURN PATH CONSIDERATIONS

The LH0036 exhibits input bias currents typically in the 40 nA region in each input. This current must flow through R_{ISO} as shown in Figure 12.

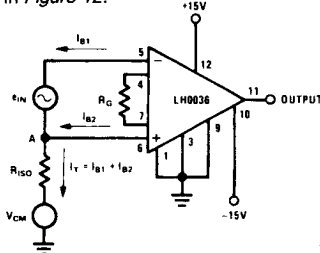

TL/H/5545-16

FIGURE 12. Bias Current Return Path

In a typical application, $V_S = \pm 15V$, $I_{B1} \cong I_{B2} \cong 40$ nA, the total current, I_T , would flow through R_{ISO} causing a voltage rise at point A. For values of $R_{ISO} \geq 150$ M Ω , the voltage at point A exceeds the +12V common range of the device. Clearly, for $R_{ISO} = \infty$, the LH0036 would be driven to positive saturation.

The implication is that a finite impedance must be supplied between the input and power supply ground. The value of the resistor is dictated by the maximum input bias current, and the common mode voltage. Under worst case conditions:

$$R_{ISO} \leq \frac{V_{CMR} - V_{CM}}{I_T} \quad (9)$$

Where:

V_{CMR} = Common Mode Range (10V for the LH0036)

V_{CM} = Common Mode Voltage

$I_T = I_{B1} + I_{B2}$

In applications in which the signal source is floating, such as a thermocouple, one end of the source may be grounded directly or through a resistor.

GUARD OUTPUT

Pin 2 of the LH0036 is provided as a guard drive pin in those stringent applications which require very low leakage and minimum input capacitance. Pin 2 will always be biased at the input common mode voltage. The source impedance looking into pin 2 is approximately 15 k Ω . Proper use of the guard/shield pin is shown in Figure 13.

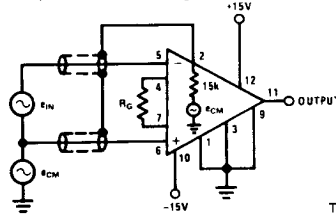

TL/H/5545-15

FIGURE 13. Use of Guard

For applications requiring a lower source impedance than 15 k Ω , a unity gain buffer, such as the LH0002 may be inserted between pin 2 and the input shields as shown in Figure 14.

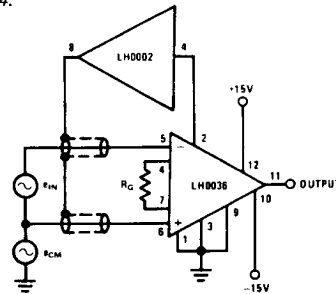

TL/H/5545-17

FIGURE 14. Guard Pin With Buffer

Definition of Terms

Bandwidth: The frequency at which the voltage gain is reduced to 0.707 of the low frequency (dc) value.

Closed Loop Gain, A_{VCL} : The ratio of the output voltage swing to the input voltage swing determined by $A_{VCL} = 1 + (50k/R_G)$. Where: R_G = Gain Set Resistor.

Common Mode Rejection Ratio: The ratio of input voltage range to the peak-to-peak change in offset voltage over this range.

Gain Equation Accuracy: The deviation of the actual closed loop gain from the predicted closed loop gain, $A_{VCL} = 1 + (50k/R_G)$ for the specified closed loop gain.

Input Bias Current: The current flowing at pin 5 and 6 under the specified operating conditions.

Input Offset Current: The difference between the input bias current at pins 5 and 6; i.e. $I_{OS} = |I_5 - I_6|$.

Input Stage Offset Voltage, V_{IOS} : The voltage which must be applied to the input pins to force the output to zero volts for $A_{VCL} = 100$.

Output Stage Offset Voltage, V_{OOS} : The voltage which must be applied to the input of the output stage to produce zero output voltage. It can be measured by measuring the overall offset at unity gain and subtracting V_{IOS} .

$$V_{OOS} = \left[V_{OS} \Big|_{A_{VCL}=1} \right] - \left[V_{OS} \Big|_{A_{VCL}=1000} \right]$$

Overall Offset Voltage:

$$V_{OS} = V_{IOS} + \frac{V_{OOS}}{A_{VCL}}$$

Power Supply Rejection Ratio: The ratio of the change in offset voltage, V_{OS} , to the change in supply voltage producing it.

Resistor, R_B : An optional resistor placed between pin 3 of the LH0036 and ground (or V^-) to reduce the input bias current.

Resistor, R_{BW} : An optional resistor placed between pin 1 of the LH0036 and ground (or V^-) to reduce the bandwidth of the output stage.

Resistor, R_G : A gain setting resistor connected between pins 4 and 7 of the LH0036 in order to program the gain from 1 to 1000.

Settling Time: The time between the initiation of an input step function and the time when the output voltage has settled to within a specified error band of the final output voltage.